

A 501 PAM B5/B14

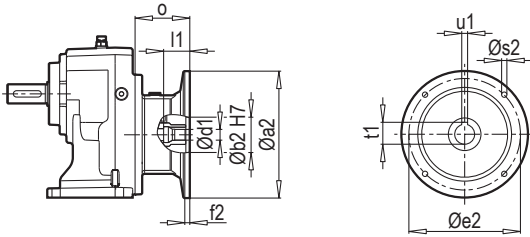

A 501 W

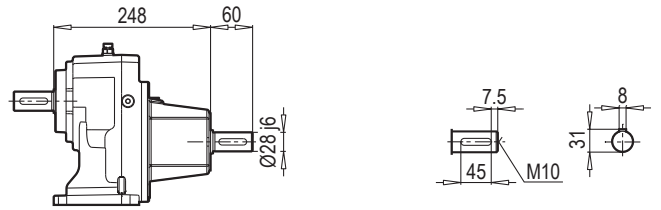

F 501 PAM B5/B14

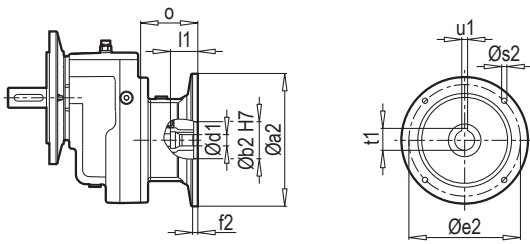

F 501 W

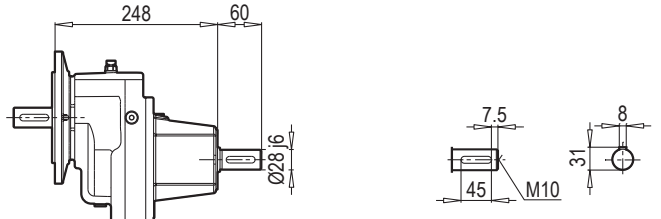

AF 501 PAM B5/B14

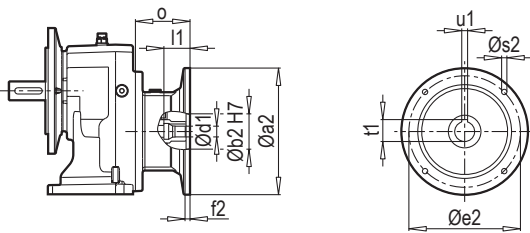

AF 501 W

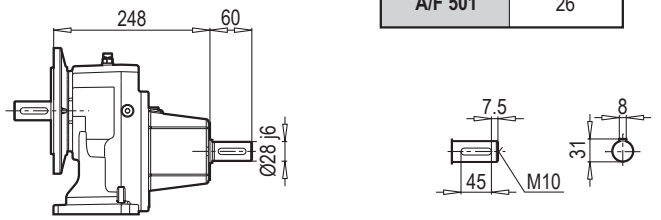

W ~	
A/F 501	26

AF-M 501 PAM B5/B14

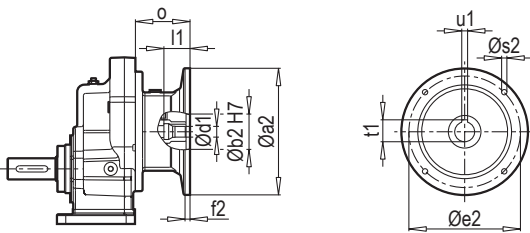

AF-M 501 W

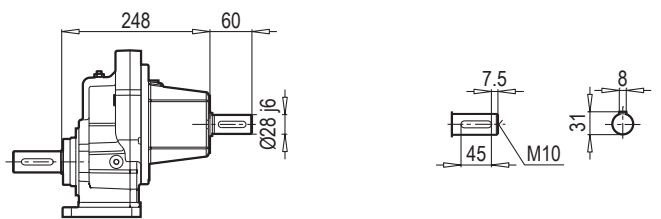

Редуктор	PAM B5	Øa2	Øb2	Øe2	f2	Øs2	Ød1	l1	t1	u1	o
A/F 501	80	200	130	165	5	M10	19	42	21.8	6	70
	90	200	130	165	5	M10	24	52	27.3	8	70
	100	250	180	215	5.5	M12	28	62	31.3	8	85
	112	250	180	215	5.5	M12	28	62	31.3	8	85
	132	300	230	265	5.5	M12	38	82	41.3	10	110

~	
PAM B5	A/F 501
80	22
90	22
100	25
112	25
132	27

Редуктор	PAM B14	Øa2	Øb2	Øe2	f2	Øs2	Ød1	l1	t1	u1	o
A/F 501	80	120	80	100	3	7	19	42	21.8	6	70
	90	140	95	115	3	9	24	52	27.3	8	70
	100	160	110	130	3.5	9	28	62	31.3	8	85
	112	160	110	130	3.5	9	28	62	31.3	8	85
	132	200	130	165	3.5	11	38	82	41.3	10	110

~	
PAM B14	A/F 501
80	18.5
90	18.5
100	21
112	21
132	24

A 502-503

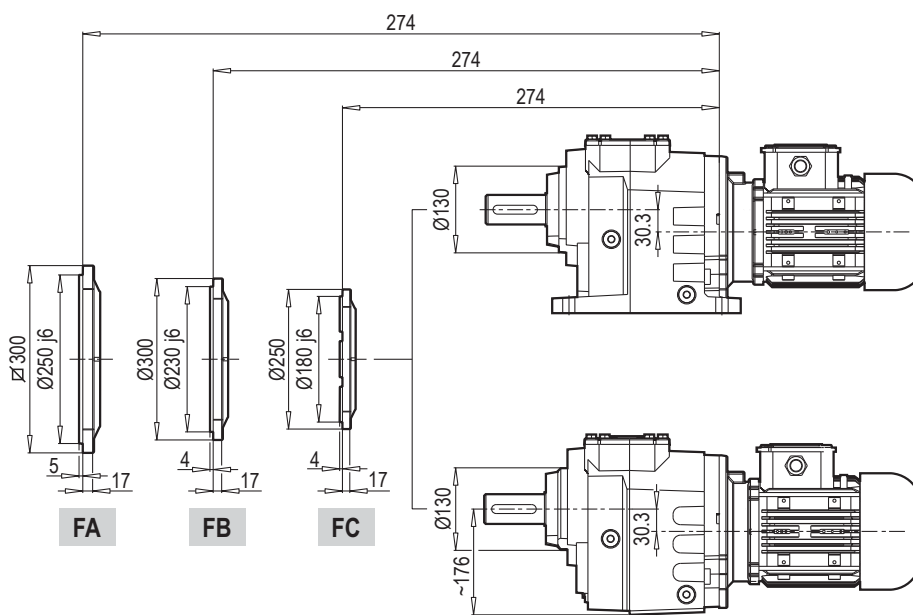
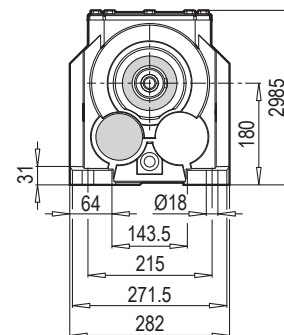
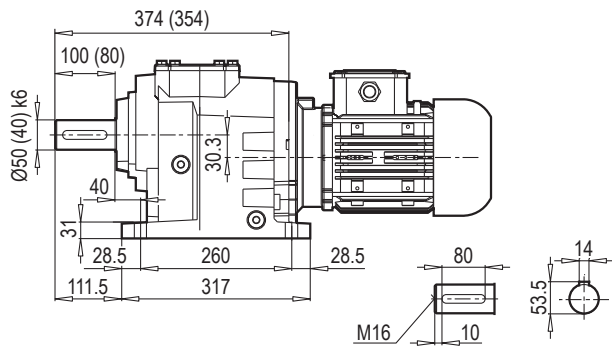

AF 502-503

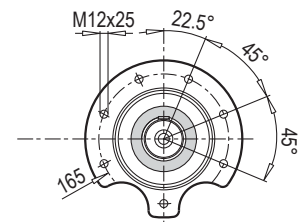

F 502-503

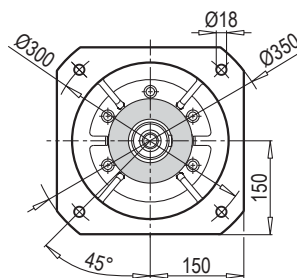
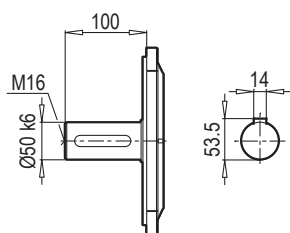

FA

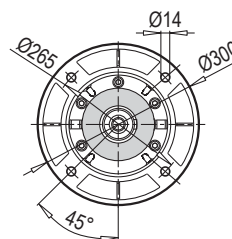

FB

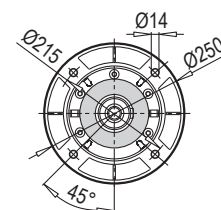

FC

A 502-503 PAM B5/B14

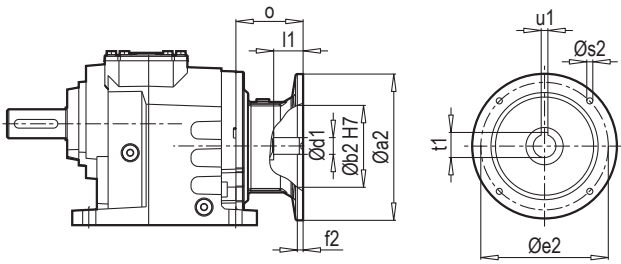

A 502-503 W

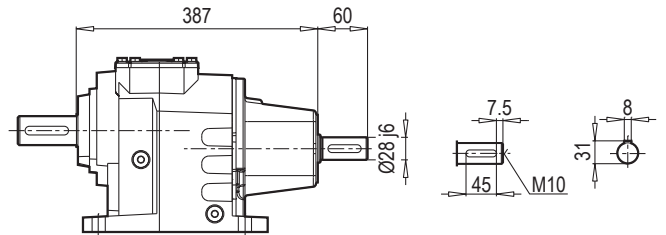

F 502-503 PAM B5/B14

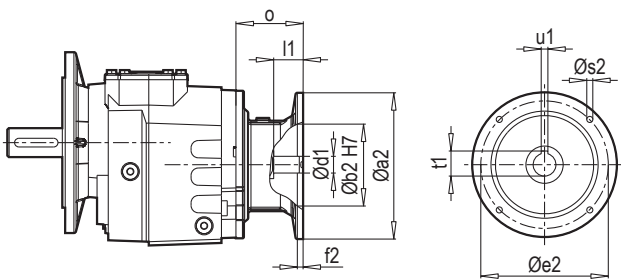

F 502-503 W

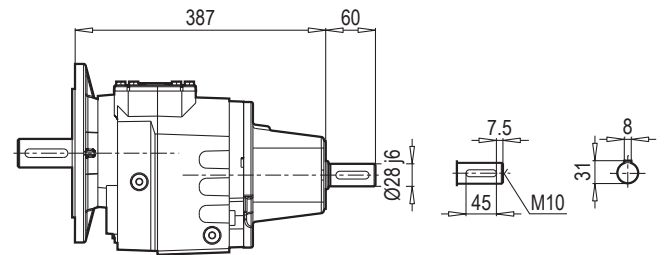

AF 502-503 PAM B5/B14

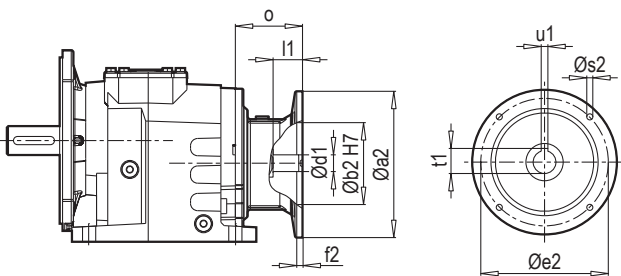

AF 502-503 W

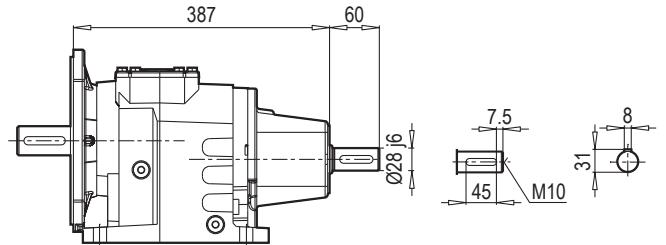

$\sim \frac{K_r}{K_f}$	
A/F 502-503	54

Редуктор	PAM B5	Øa2	Øb2	Øe2	f2	Øs2	Ød1	l1	t1	u1	o
A/F 502 A/F 503	80	200	130	165	5	M10	19	42	21.8	6	70
	90	200	130	165	5	M10	24	52	27.3	8	70
	100	250	180	215	5.5	M12	28	62	31.3	8	85
	112	250	180	215	5.5	M12	28	62	31.3	8	85
	132	300	230	265	5.5	M12	38	82	41.3	10	110
	160	350	250	300	7	M16	42	112	45.3	12	158

$\sim \frac{K_r}{K_f}$	
PAM B5	A/F 502-503
80	52
90	52
100	54
112	54
132	58
160	65

Редуктор	PAM B14	Øa2	Øb2	Øe2	f2	Øs2	Ød1	l1	t1	u1	o
A/F 502 A/F 503	80	120	80	100	3	7	19	42	21.8	6	70
	90	140	95	115	3	9	24	52	27.3	8	70
	100	160	110	130	3.5	9	28	62	31.3	8	85
	112	160	110	130	3.5	9	28	62	31.3	8	85
	132	200	130	165	3.5	11	38	82	41.3	10	110

$\sim \frac{K_r}{K_f}$	
PAM B14	A/F 502-503
80	48
90	48
100	50
112	50
132	55